

Tab 95

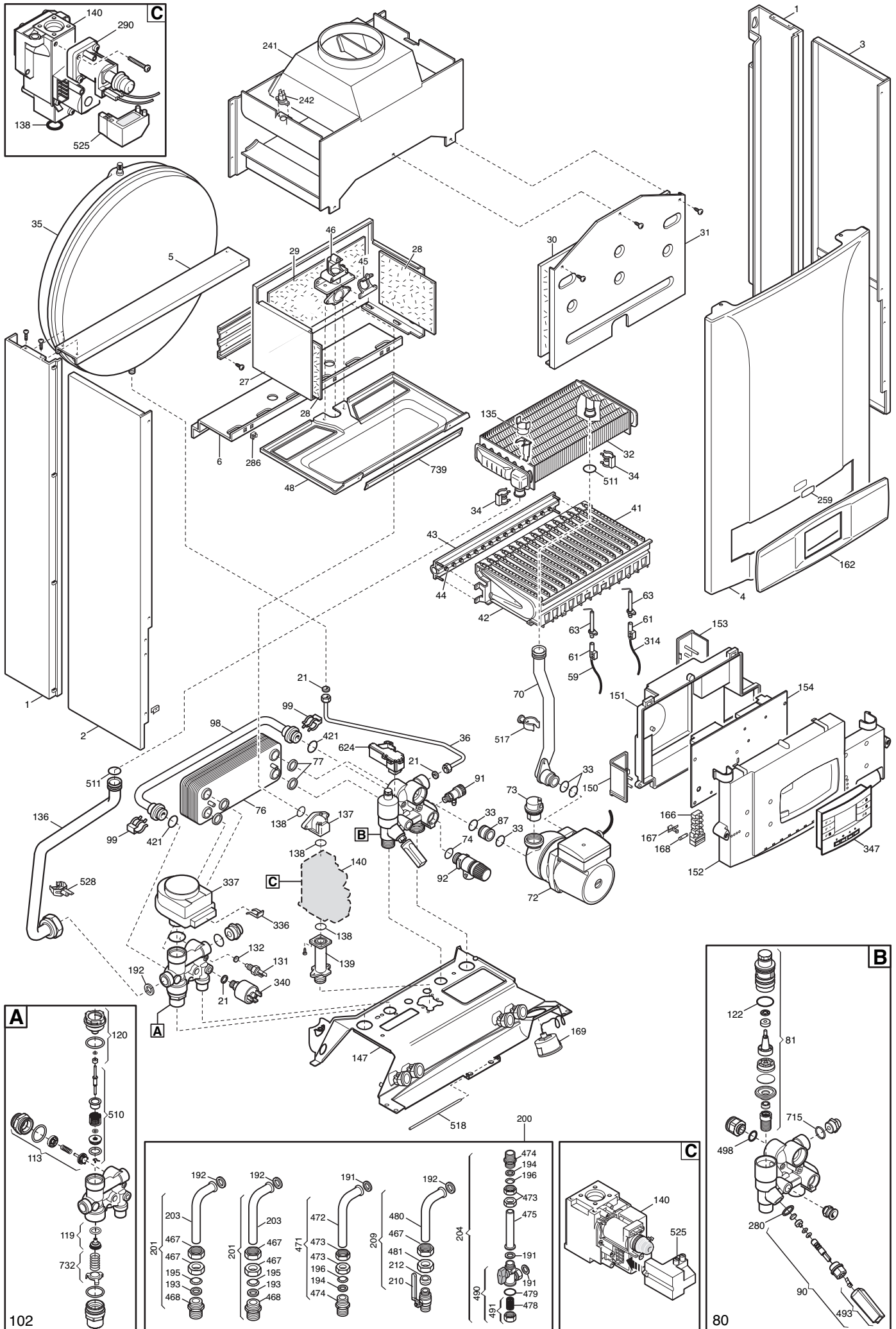

Tab 344

