

Tab 94

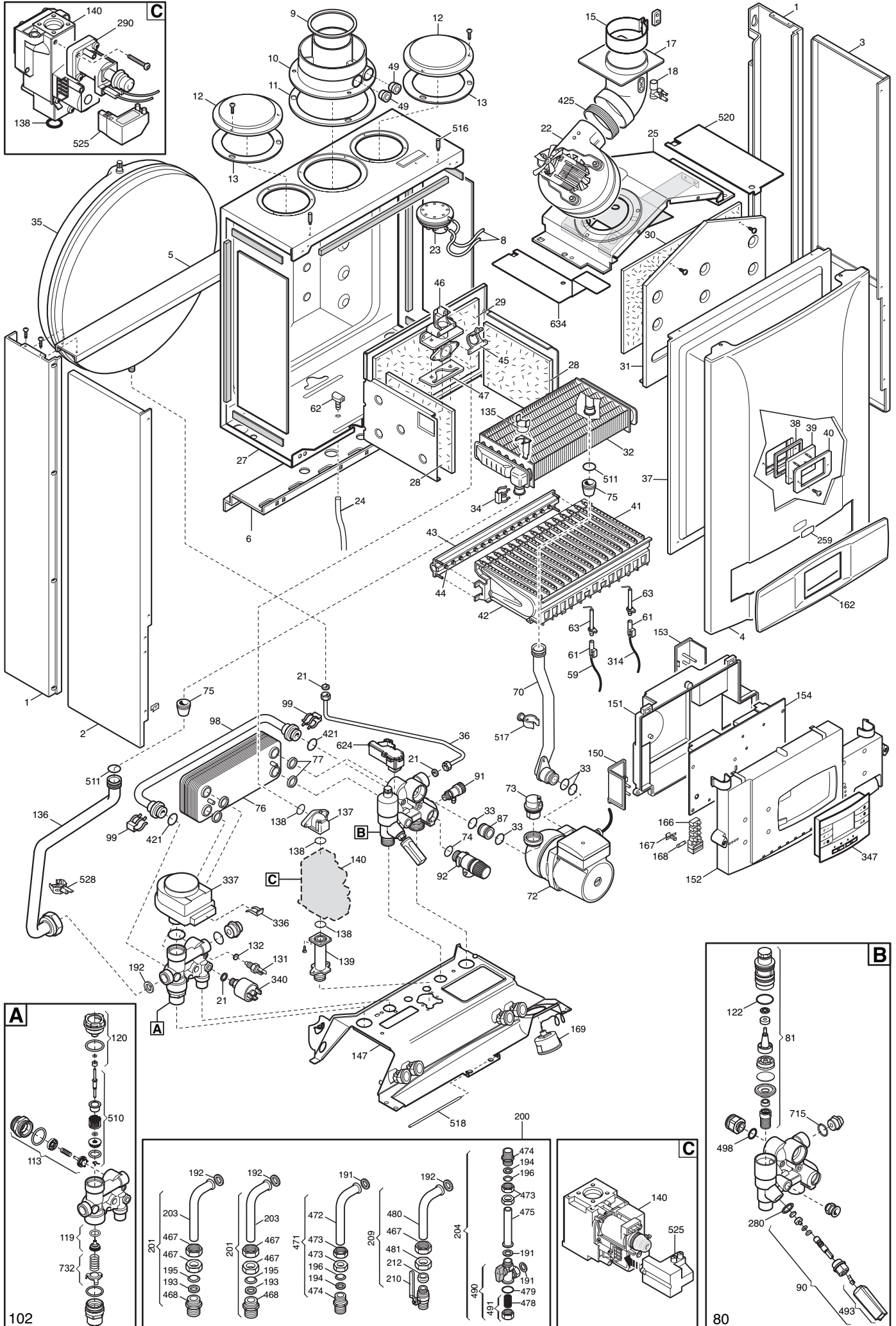

Tab 343

