

Tab 124

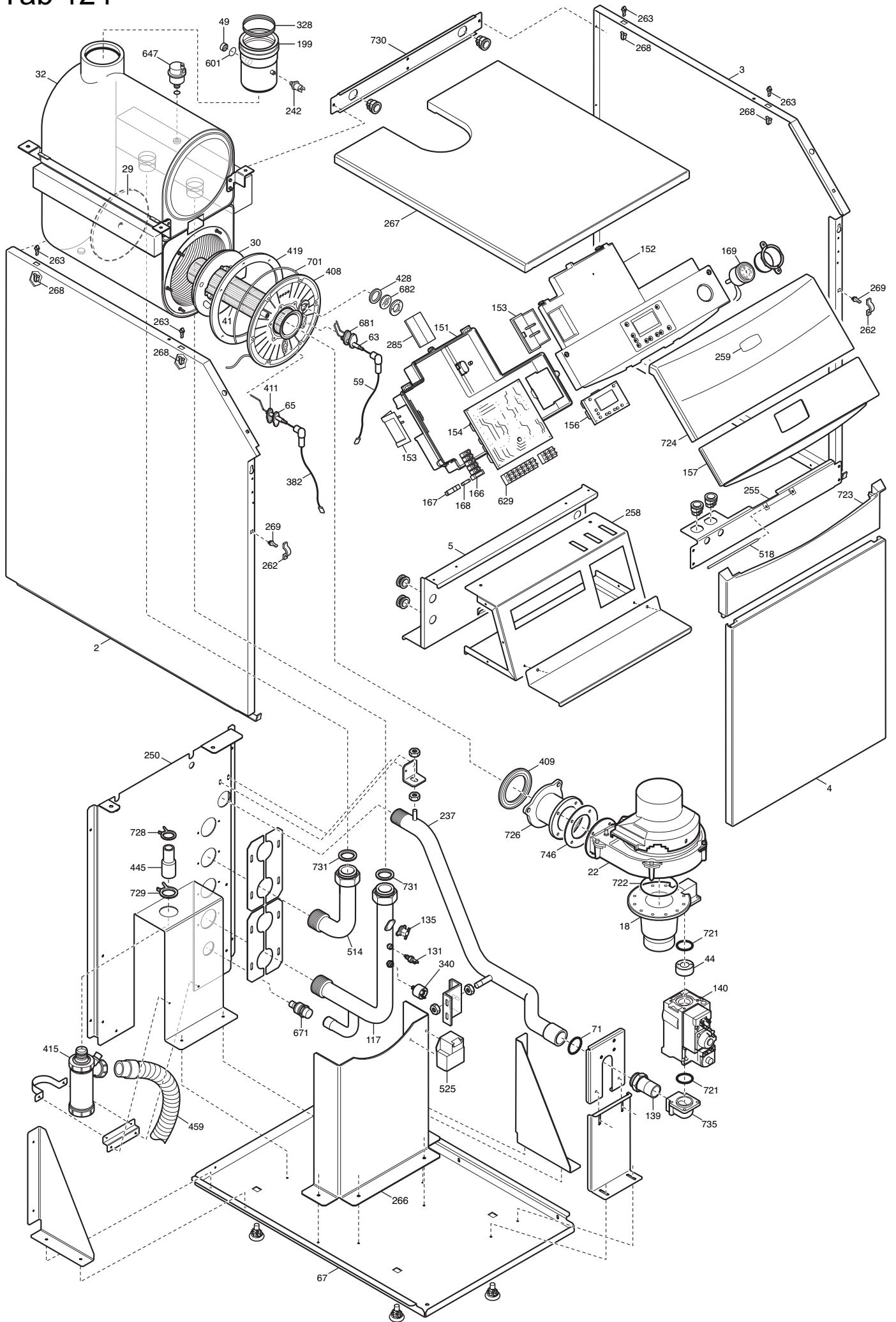

Tab 370

